

IGBT Modules

Sixpack

Short Circuit SOA Capability
Square RBSOA

$I_{C25} = 160 \text{ A}$
 $V_{CES} = 1200 \text{ V}$
 $V_{CE(sat) \text{ typ.}} = 2.2 \text{ V}$

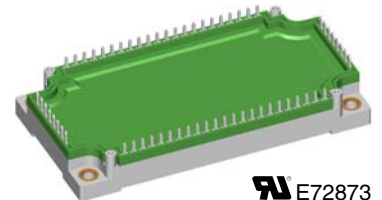
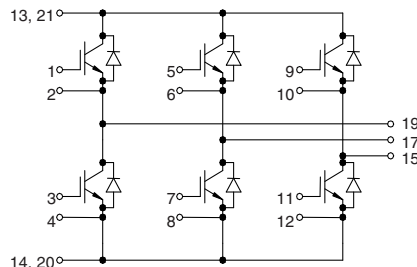

IXYS E72873

See outline drawing for pin arrangement

IGBTs

Symbol	Conditions	Maximum Ratings	
V_{CES}	$T_{VJ} = 25^{\circ}\text{C to } 150^{\circ}\text{C}$	1200	V
V_{GES}		± 20	V
I_{C25}	$T_C = 25^{\circ}\text{C}$	160	A
I_{C80}	$T_C = 80^{\circ}\text{C}$	110	A
RBSOA	$V_{GE} = \pm 15 \text{ V}$; $R_G = 6.8 \ \Omega$; $T_{VJ} = 125^{\circ}\text{C}$ Clamped inductive load; $L = 100 \ \mu\text{H}$	$I_{CM} = 200$ $V_{CEK} \leq V_{CES}$	A
t_{SC} (SCSOA)	$V_{CE} = V_{CES}$; $V_{GE} = \pm 15 \text{ V}$; $R_G = 6.8 \ \Omega$; $T_{VJ} = 125^{\circ}\text{C}$ non-repetitive	10	μs
P_{tot}	$T_C = 25^{\circ}\text{C}$	640	W

Features

- €NPT IGBT technology
- €low saturation voltage
- €low switching losses
- €switching frequency up to 30 kHz
- €square RBSOA, no latch up
- €high short circuit capability
- €positive temperature coefficient for easy paralleling
- €MOS input, voltage controlled
- €ultra fast free wheeling diodes
- €solderable pins for PCB mounting
- €package with copper base plate

Advantages

- €space savings
- €reduced protection circuits
- €package designed for wave soldering

Typical Applications

- €AC motor control
- €AC servo and robot drives
- €power supplies

Symbol	Conditions	Characteristic Values ($T_{VJ} = 25^{\circ}\text{C}$, unless otherwise specified)			
		min.	typ.	max.	
$V_{CE(sat)}$	$I_C = 100 \text{ A}$; $V_{GE} = 15 \text{ V}$; $T_{VJ} = 25^{\circ}\text{C}$ $T_{VJ} = 125^{\circ}\text{C}$		2.2 2.5	V V	
$V_{GE(th)}$	$I_C = 4 \text{ mA}$; $V_{GE} = V_{CE}$	4.5		6.5 V	
I_{CES}	$V_{CE} = V_{CES}$; $V_{GE} = 0 \text{ V}$; $T_{VJ} = 25^{\circ}\text{C}$ $T_{VJ} = 125^{\circ}\text{C}$		4	6.3 mA mA	
I_{GES}	$V_{CE} = 0 \text{ V}$; $V_{GE} = \pm 20 \text{ V}$			400 nA	
$t_{d(on)}$ t_r $t_{d(off)}$ t_f E_{on} E_{off}	Inductive load, $T_{VJ} = 125^{\circ}\text{C}$ $V_{CE} = 600 \text{ V}$; $I_C = 100 \text{ A}$ $V_{GE} = \pm 15 \text{ V}$; $R_G = 6.8 \ \Omega$		100 60 600 90	ns ns ns ns	
			16.1	mJ	
			14.6	mJ	
C_{ies}		$V_{CE} = 25 \text{ V}$; $V_{GE} = 0 \text{ V}$; $f = 1 \text{ MHz}$		6.5	nF
Q_{Gon}		$V_{CE} = 600 \text{ V}$; $V_{GE} = 15 \text{ V}$; $I_C = 100 \text{ A}$		475	nC
R_{thJC}		(per IGBT)			0.19 K/W

IXYS reserves the right to change limits, test conditions and dimensions.

20070912a

Diodes

Symbol	Conditions	Maximum Ratings	
I_{F25}	$T_C = 25^\circ\text{C}$	200	A
I_{F80}	$T_C = 80^\circ\text{C}$	130	A

Symbol	Conditions	Characteristic Values		
		min.	typ.	max.
V_F	$I_F = 100\text{ A}; V_{GE} = 0\text{ V}; T_{VJ} = 25^\circ\text{C}$ $T_{VJ} = 125^\circ\text{C}$	2.3	2.6	V
I_{RM} t_{rr}	$I_F = 120\text{ A}; di_F/dt = -750\text{ A}/\mu\text{s}; T_{VJ} = 125^\circ\text{C}$ $V_R = 600\text{ V}; V_{GE} = 0\text{ V}$	82		A
		200		ns
R_{thJC}	(per diode)			0.3 K/W

Module

Symbol	Conditions	Maximum Ratings	
T_{VJ}	operating	-40...+125	$^\circ\text{C}$
T_{JM}		+150	$^\circ\text{C}$
T_{stg}		-40...+125	$^\circ\text{C}$
V_{ISOL}	$I_{ISOL} \leq 1\text{ mA}; 50/60\text{ Hz}$	2500	V~
M_d	Mounting torque (M5)	3 - 6	Nm

Symbol	Conditions	Characteristic Values		
		min.	typ.	max.
$R_{pin-chip}$			1.8	m Ω
d_S	Creepage distance on surface	10		mm
d_A	Strike distance in air	10		mm
R_{thCH}	with heatsink compound		0.01	K/W
Weight			300	g

Dimensions in mm (1 mm = 0.0394")

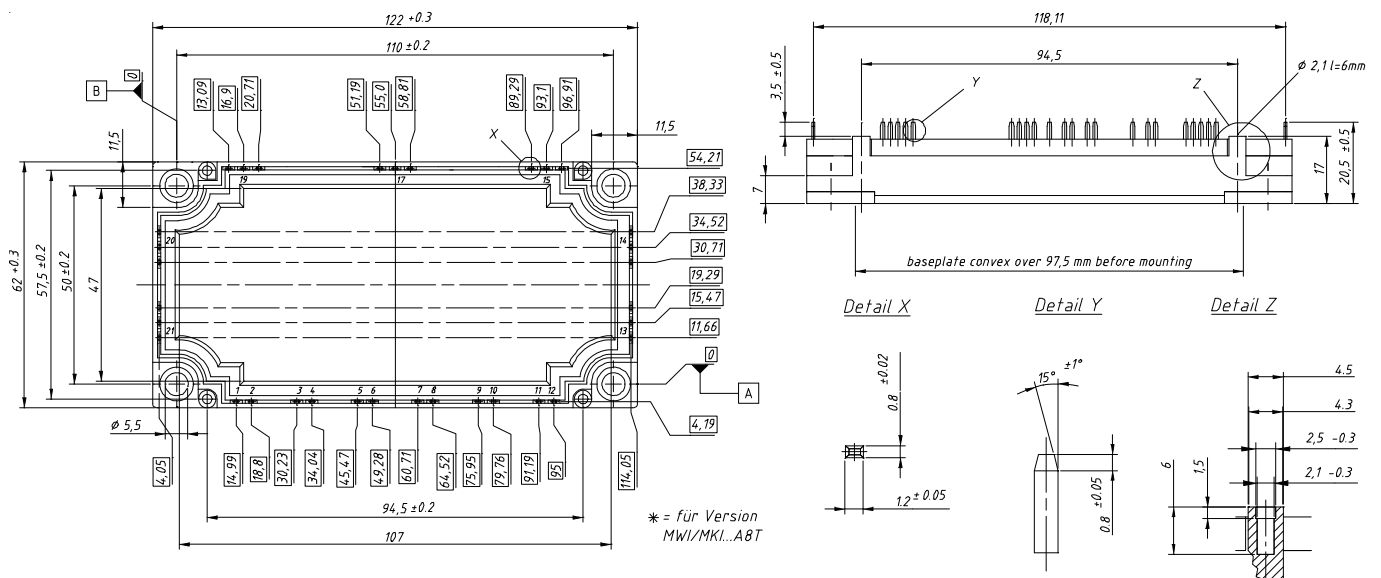

Equivalent Circuits for Simulation

Conduction

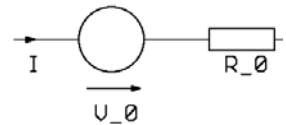

IGBT (typ. at $V_{GE} = 15\text{ V}; T_J = 125^\circ\text{C}$)
 $V_0 = 1.3\text{ V}; R_0 = 12\text{ m}\Omega$

Free Wheeling Diode (typ. at $T_J = 125^\circ\text{C}$)
 $V_0 = 1.27\text{ V}; R_0 = 4.3\text{ m}\Omega$

Thermal Response

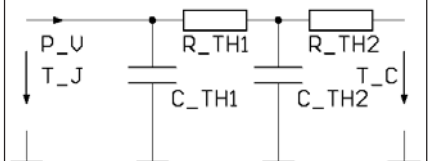

IGBT (typ.)

$C_{th1} = 0.397\text{ J/K}; R_{th1} = 0.141\text{ K/W}$
 $C_{th2} = 2.243\text{ J/K}; R_{th2} = 0.049\text{ K/W}$

Free Wheeling Diode (typ.)

$C_{th1} = 0.301\text{ J/K}; R_{th1} = 0.238\text{ K/W}$
 $C_{th2} = 2.005\text{ J/K}; R_{th2} = 0.062\text{ K/W}$

IXYS reserves the right to change limits, test conditions and dimensions.

© 2007 IXYS All rights reserved

20070912a

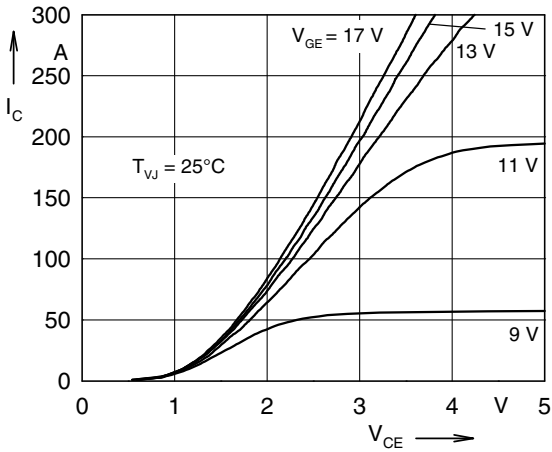

Fig. 1 Typ. output characteristics

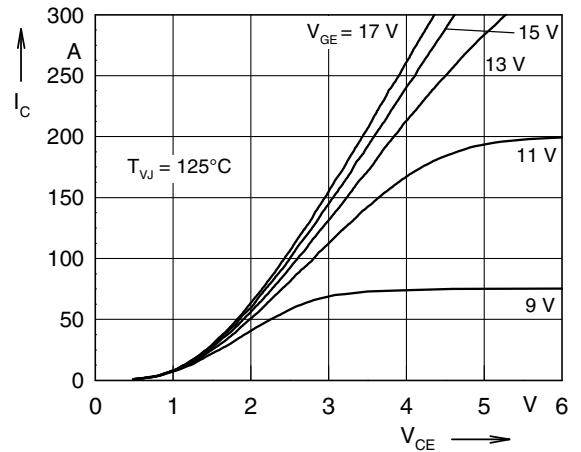

Fig. 2 Typ. output characteristics

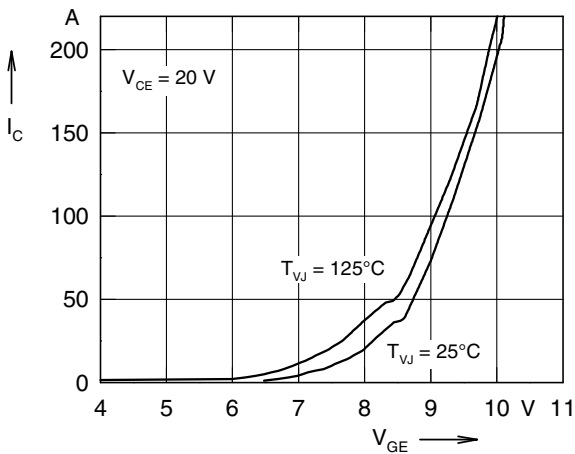

Fig. 3 Typ. transfer characteristics

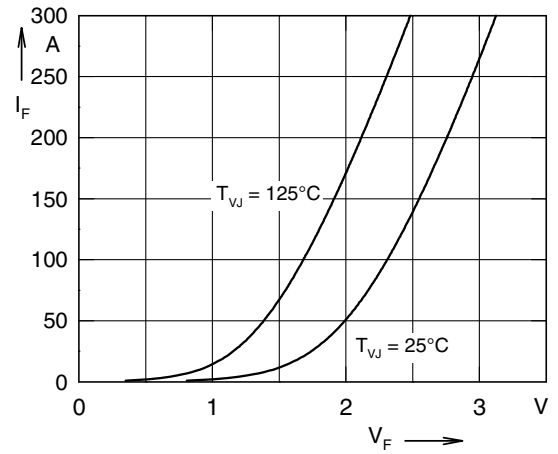

Fig. 4 Typ. forward characteristics of free wheeling diode

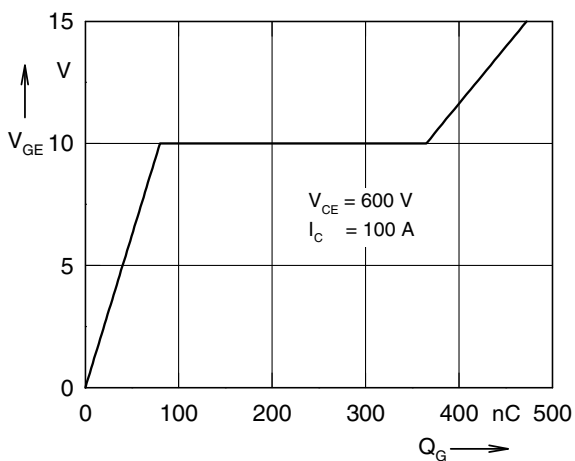

Fig. 5 Typ. turn on gate charge

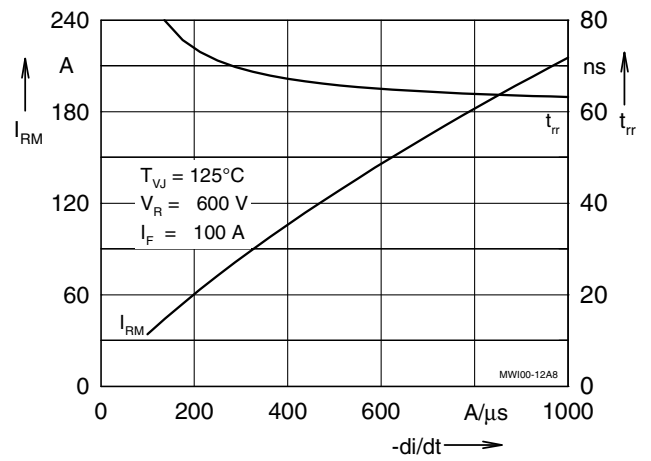

Fig. 6 Typ. turn off characteristics of free wheeling diode

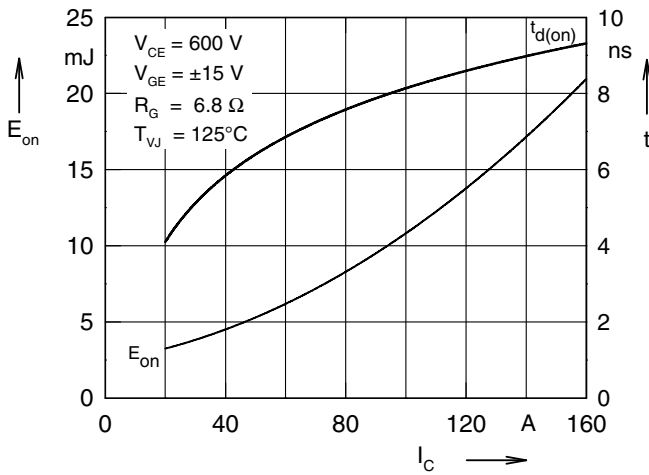

Fig. 7 Typ. turn on energy and switching times versus collector current

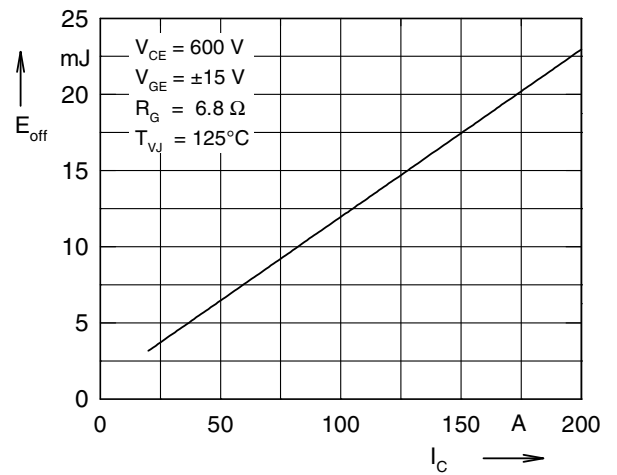

Fig. 8 Typ. turn off energy and switching times versus collector current

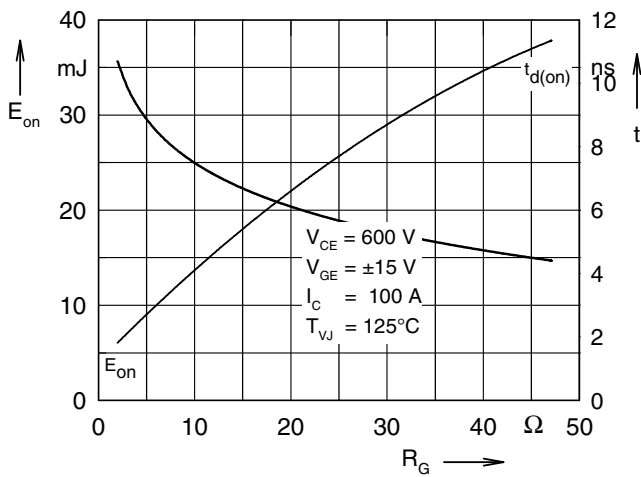

Fig. 9 Typ. turn on energy and switching times versus gate resistor

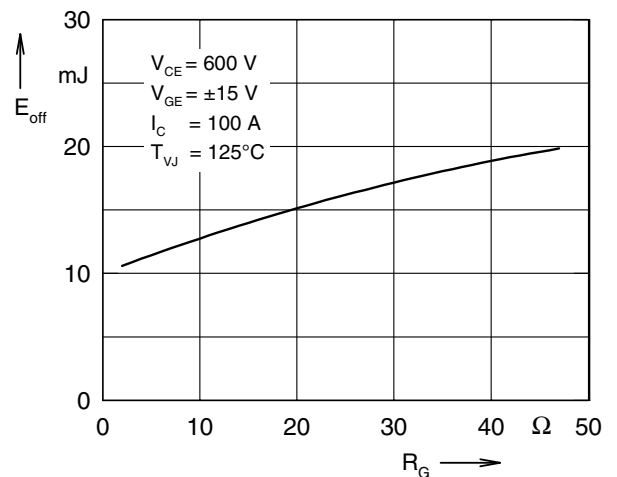

Fig.10 Typ. turn off energy and switching times versus gate resistor

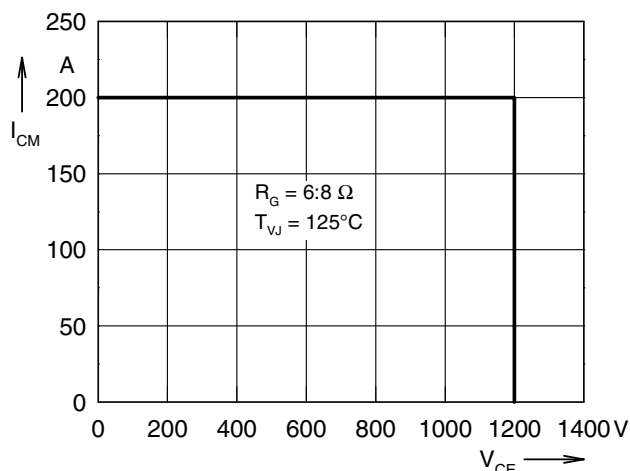

Fig. 11 Reverse biased safe operating area RBSOA

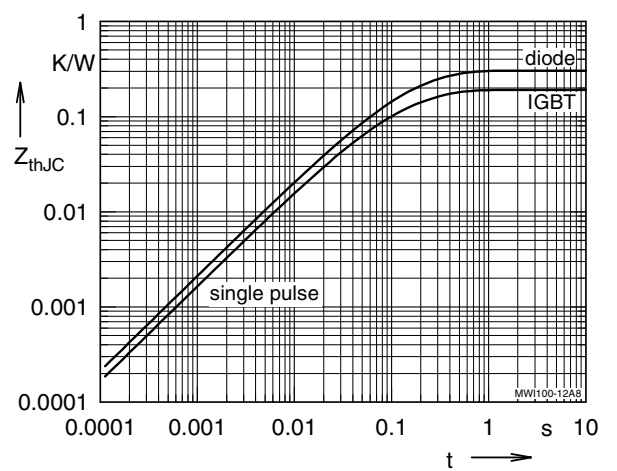

Fig. 12 Typ. transient thermal impedance